

H2S SS SENSOR – MICRO SOLID STATE HYDROGEN SULPHIDE 500PPM

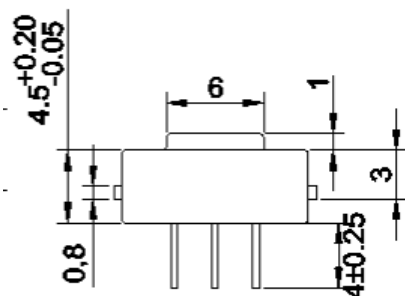
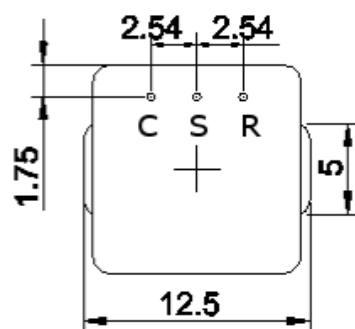
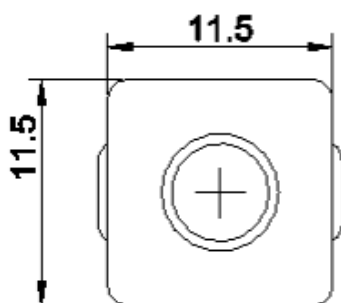
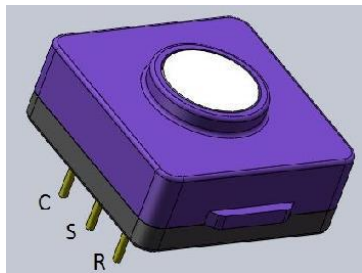

FEATURES

- **Extreme linear response up to high concentration**
- **Micro size ideal for portable, fixed, wireless and digital gas detection applications**
- **High sensitivity, fast response with low noise**
- **Solid state long lifetime technology without risk of leakage**

SPECIFICATION

Measuring Principle:	Amperometric, 3-electrode sensor
Detectable Gases:	Hydrogen Sulphide H2S
Standard Range: (Optional Ranges:	0 – 500 ppm H2S 0-100ppm, 0-5000 ppm on request)
Lower Detectable Limit (LDL):	≤ 1 ppm
Maximum Range:	1000 ppm
Long Term Sensitivity Drift:	< 1% / month
Sensitivity:	90 ± 20 nA/ppm
Zero current at normal conditions:	± 20 nA
Response Time (T50):	< 10 seconds
Response Time (T90):	< 30 seconds
Sensor Warm-Up Time:	< 60 seconds
Repeatability:	1 %
Resolution (16 Bit ADC):	0.1 ppm
Linear range:	1000 ppm
Expected Operating Life:	> 3 years

Note: PCB sockets are recommended for the sensor pin connection. Soldering or using glue with the sensor should be avoided and will invalidate warranty. Socket connector information available on request.

All dimensions are in mm. Tolerances are +/- 0.10mm unless otherwise stated.



EURO-GAS MANAGEMENT SERVICES LTD, CHURSTON HOUSE,
BASCOMBE ROAD, CHURSTON FERRERS, DEVON, TQ5 0JJ, UK

☎: +44 (0)1803 844414 Fax: +44 (0)1803 844224

sales@euro-gasman.com

www.euro-gasman.com

EURO-GAS
MANAGEMENT SERVICES LTD

H2S SS SENSOR – MICRO SOLID STATE HYDROGEN SULPHIDE 500PPM

SPECIFICATION

Temperature Range:	-40°C to +50°C
Humidity Range (non-condensing):	10 – 95% RH
Pressure Range:	800 to 1200 HPa
Bias Voltage:	0 mV
Recommended load resistor:	100 Ω
Zero drift in clean air:	< 2 ppm
Storage temperature:	0°C to +20°C
Storage conditions:	6 months in original container
Housing material:	ABS
Weight:	< 0.7g
Sensor dimensions:	12.5mm x 11.5mm x 9.5mm
Warranty Period:	24 months from date of despatch
Part Number:	2112B012720

Accessories:

- Precision SIP terminals for sensor pin connection
- i2c and voltage miniature transmitter, part no. 2112B019900

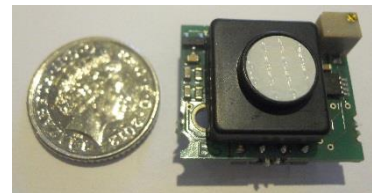

Transmitter accessory for Micro sensors - i2c and voltage outputs, part no. 2112B019900

TEMPERATURE CO-EFFICIENT

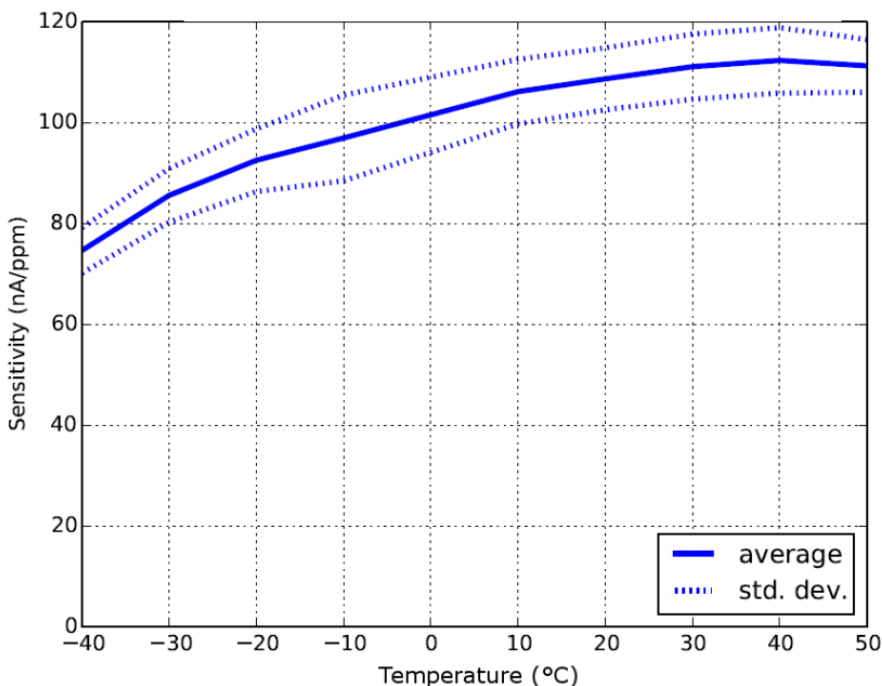

Note: PCB sockets are recommended for the sensor pin connection. Soldering or using glue with the sensor should be avoided and will invalidate warranty.

All performance specifications are based upon the following environment conditions: +23°C, 50% relative humidity, 1 atm (1013 mBar or ambient pressure), flow rate > 150qcm/min.

H2S SS SENSOR – MICRO SOLID STATE HYDROGEN SULPHIDE 500PPM

CROSS SENSITIVITY DATA

GAS	TEST CONCENTRATION	READING IN PPM
Ammonia NH ₃	50ppm	0ppm
Carbon Dioxide CO ₂	1000ppm	0ppm
Carbon Monoxide CO	50ppm	3ppm
Chlorine Cl ₂	10ppm	-1.5ppm
Hydrogen H ₂	100ppm	3ppm
Hydrocarbons unsaturated	1%	Not applicable
Hydrogen Cyanide HCN	10ppm	0ppm
Isopropanol C ₃ H ₇ OH	1000ppm	Not expected
Nitrogen Dioxide NO ₂	10ppm	-2.2ppm
Nitric Oxide NO	25ppm	Not applicable

Sensor performance is temperature dependent. All performance specifications are based on test conditions with new sensors with the following environment conditions: +23°C, 50% relative humidity, 1 atm (1013 mBar or ambient pressure), flow rate > 150qcm/min. Cross-sensitivity gases are not target gases. Relationship can change overtime.

Whilst the SS sensor is designed to be highly specific to the gas it is intended to measure, it will still respond to some degree to various gases. The table is not exclusive and other gases not included in the table may still cause a sensor to react.

The cross-sensitivity values quoted are based on tests conducted on a small number of sensors. They are intended to indicate sensor response to gases other than the target gas. Sensors may behave differently with changes in ambient conditions and any batch may show significant variation from the values quoted.

The figures in this table are typical values and should not be used as a basis for cross calibration. Cross sensitivities may not be linear and should not be scaled. For some cross interference, break through will occur if gas is applied for a longer time period.

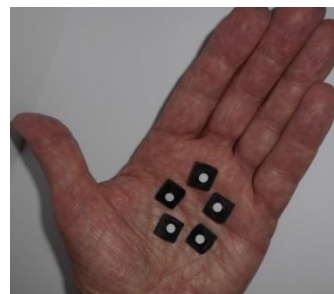

Notes: PCB sockets are recommended for the sensor pin connection. Soldering or using glue with the sensor should be avoided and will invalidate warranty. Socket connector information available on request. Sensors are designed to operate in a wide range of harsh environments and conditions. However, it is important to avoid exposure to high concentrations of solvent during storage, fitting into instrumentation and operation. When using sensors on PCBs, degreasing agents should be used prior to the sensor being fitted.

By the nature of the technology used, any sensor can potentially fail to meet specification without warning. Euro-Gas makes every effort to ensure reliability of all sensors but where life safety is a performance requirement of the product and, where practical, Euro-Gas recommends that all gas sensors and instruments using sensors are checked for response to gas before use. The data contained in this document is believed to be accurate and reliable. The data given is for guidance only. Euro-Gas Management Services Ltd accepts no liability for any consequential losses, injury or damage resulting from the use of this datasheet or the information contained in it. Customers should test the sensors under their own conditions to ensure that the sensors are suitable for their own requirements and in accordance with the plans and circumstances of the specific project and any standards/regulations pertaining to the country in which the sensors will be utilised. Performance characteristics on this data sheet outline the performance of newly supplied sensors. Output signal can drift below the lower limit over time. This datasheet is not intended to form the basis of a contract and in the interest of product improvement, Euro-Gas reserves the right to alter design features and specifications without notice. 04/16



**EURO-GAS MANAGEMENT SERVICES LTD, CHURSTON HOUSE,
BASCOMBE ROAD, CHURSTON FERRERS, DEVON, TQ5 0JJ, UK**

☎: +44 (0)1803 844414 Fax: +44 (0)1803 844224

sales@euro-gasman.com

www.euro-gasman.com

EURO-GAS
MANAGEMENT SERVICES LTD