

MICRO SS SENSOR 200PPM SOLID STATE MULTI-GAS / VOC

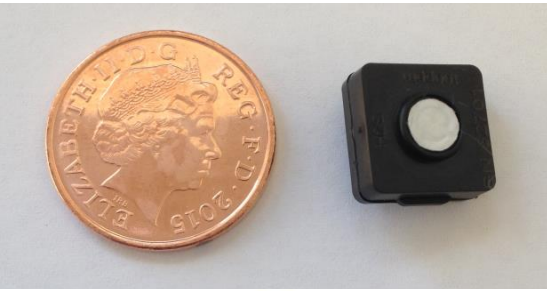

FEATURES

- Micro size ideal for portable, fixed, wireless and digital gas detection applications
- High sensitivity, fast response with low noise
- Solid state long lifetime technology of greater than 3 years without risk of leakage
- Low cost alternative to PID detection
- Extreme linear response
- Typical warm up time in seconds
- nA power consumption
- No or low zero line drift
- Better signal to noise ratio
- Wide temperature range with excellent sensitivity at low temperatures
- Low or no cross-interference with other environmental gases
- RoHS compliant

TYPICAL APPLICATIONS

- Industrial safety & leakage detection
- VOC gas detection
- Gas manufacturing process monitoring
- Outdoor & indoor air quality
- Emission monitoring
- Sewage & Water Treatment
- Biogas
- Food Industry
- Medical & Healthcare
- Consumer markets

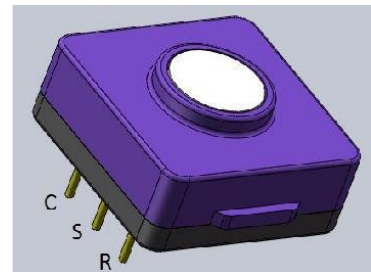

EURO-GAS MANAGEMENT SERVICES LTD, CHURSTON HOUSE,
BASCOMBE ROAD, CHURSTON FERRERS, DEVON, TQ5 0JJ, UK

☎: +44 (0)1803 844414

sales@euro-gasman.com

www.euro-gasman.com



EURO-GAS
MANAGEMENT SERVICES LTD

MICRO SS SENSOR 200PPM SOLID STATE MULTI-GAS / VOC

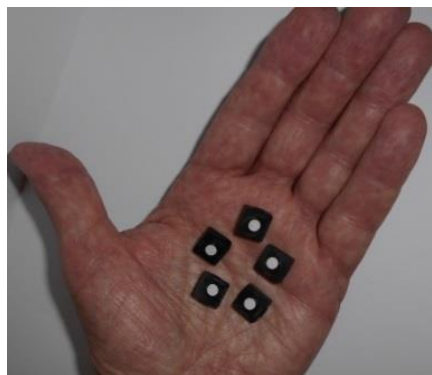
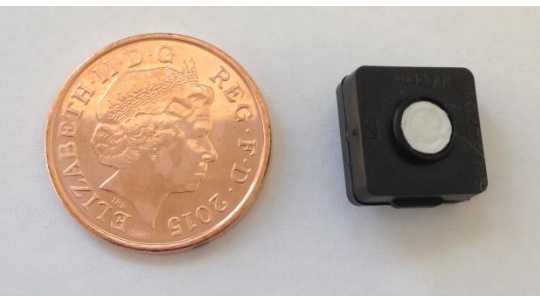

SPECIFICATION

Measuring Principle:	Amperometric, 3-electrode sensor
Detectable Gases:	Multi-gases and Volatile Organic Compounds VOC
Standard Range:	0 – 200 ppm
Optional Ranges on request:	0-10ppm, 0-1000ppm, 0-2000ppm
Maximum Over-Range:	1000 ppm
Sensitivity:	40 ± 10 nA/ppm calibrated to CO Carbon Monoxide equivalent 55 ± 15 nA/ppm calibrated to C4H8 Isobutane equivalent
Zero current at normal conditions:	± 100 nA
Response Time (T50):	< 10 seconds
Response Time (T90):	< 30 seconds
Sensor Warm-Up Time:	< 60 seconds
Repeatability:	1 %
Resolution (16 Bit ADC):	0.1 ppm
Linearity:	Linear
Long Term Sensitivity Drift:	< 5% / year
Expected Operating Life:	> 3 years

Notes: Long-term sensitivity drift may vary subject to storage conditions, environmental conditions and use in the application.

PCB sockets are recommended for the sensor pin connection. Soldering or using glue with the sensor should be avoided and will invalidate warranty.



MICRO SS SENSOR 200PPM SOLID STATE MULTI-GAS / VOC

SPECIFICATION

Operating Temperature Range:	-40°C to +55°C
Humidity Range (non-condensing):	15 – 95% RH
Pressure Range:	800 to 1200 HPa
Bias Voltage:	0 mV
Recommended load resistor:	100 Ω
Zero drift in clean air:	< 1 ppm
Storage temperature:	0°C to +20°C (optimum 4°C to 6°C)
Storage conditions:	12 months in original container
Housing material:	PPO
Weight:	< 0.7g
Sensor dimensions:	12.5mm x 11.5mm x 9mm
Warranty Period:	12 months from date of manufacture
Part Number:	2112B012780

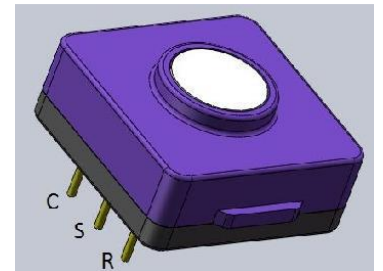
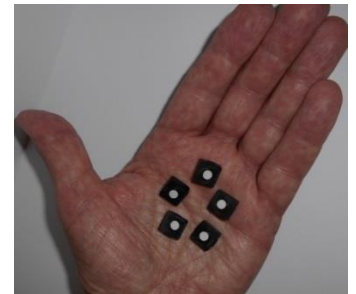

DIMENSIONS

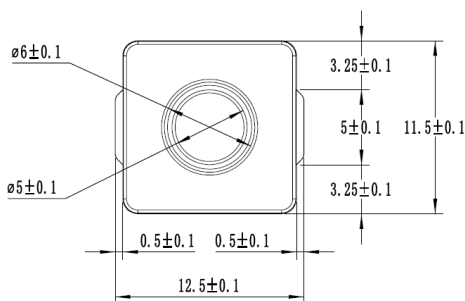

Top

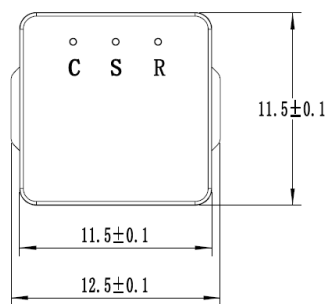

Bottom

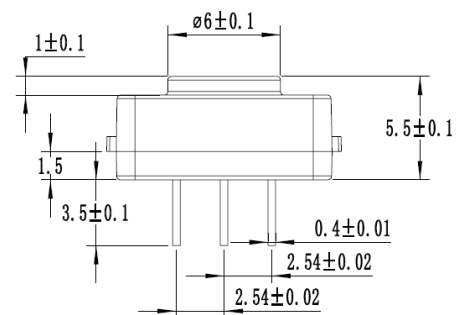

All dimensions are in mm. Tolerances are +/- 0.10mm unless otherwise stated.



MICRO SS SENSOR 200PPM SOLID STATE MULTI-GAS / VOC

TEMPERATURE CURVE

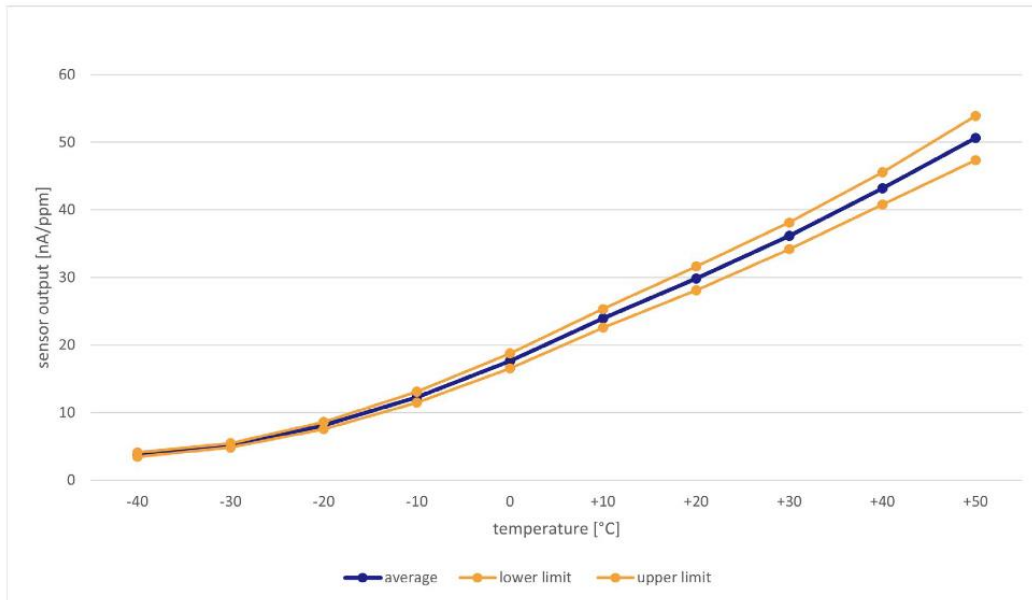

ACCESSORIES



Precision SIP terminals
for sensor pin connection,
part no. 2112B4503330



**Test and calibration
gas flow cap**, part no.
2112B013701



SS Micro TX
UART or i2c miniature
precalibrated pluggable
transmitter, part no.
2112B012780500



SS PCB
Voltage and i2c miniature precalibrated
pluggable transmitter, with onboard
temperature measurement and life test
capability, part no. 2112B019900



MICRO SS SENSOR 200PPM SOLID STATE MULTI-GAS / VOC

CROSS SENSITIVITY DATA

GAS	CALCULATED TEST CONCENTRATION	TEST CONCENTRATION	READING IN PPM
Ammonia NH ₃	20ppm	1ppm	0ppm
Arsine ASH ₃	10ppm	1ppm	4ppm
Benzene C ₆ H ₆	-	1ppm	Not expected
Bromine Br	-	1ppm	Negative reading expected
Carbon Dioxide CO ₂	-	10% vol	0% vol
Carbon Monoxide CO	100ppm	100ppm	105ppm
Chlorine Cl ₂	-	1ppm	Negative reading expected
Chlorine Dioxide ClO ₂	-	1ppm	Negative reading expected
Dichloromethane CH ₂ Cl ₂	-	1ppm	Negative reading expected
Diborane B ₂ H ₆	-	1ppm	Positive reading expected
Dimethyl Disulfide C ₂ H ₆ S ₂	-	1ppm	Positive reading expected
Ethanol (Alcohols) C ₂ H ₆ O	500ppm	1ppm	0.5ppm
Ethylene C ₂ H ₄	10ppm	1ppm	0ppm
Ethylene Oxide C ₂ H ₄ O	10ppm	1ppm	0.35ppm
Fluorine F ₂	-	1ppm	Negative reading expected
Formaldehyde HCHO	-	1ppm	Positive reading expected
Gasoline Volatilisation	-	1ppm	Positive reading expected
Germane GeH ₄	-	1ppm	Positive reading expected
Hydrazine N ₂ H ₄	-	1ppm	Positive reading expected
Hydrocarbons unsaturated	-	1ppm	Not expected
Hydrogen H ₂	500ppm	2000ppm	625ppm
Hydrogen Bromide HBr	-	1ppm	Negative reading expected
Hydrogen Chloride HCl	-	1ppm	Negative reading expected
Hydrogen Cyanide HCN	10ppm	1ppm	0.8ppm
Hydrogen Fluoride HF	-	1ppm	Negative reading expected
Iodine I	-	1ppm	Negative reading expected
Isopropanol C ₃ H ₈ O	-	1ppm	Positive reading expected
Methane CH ₄	-	1% vol	0% vol
Methanol CH ₃ OH	-	1ppm	Positive reading expected



**EURO-GAS MANAGEMENT SERVICES LTD, CHURSTON HOUSE,
BASCOMBE ROAD, CHURSTON FERRERS, DEVON, TQ5 0JJ, UK**

☎: +44 (0)1803 844414

sales@euro-gasman.com

www.euro-gasman.com

EURO-GAS
MANAGEMENT SERVICES LTD

MICRO SS SENSOR 200PPM SOLID STATE MULTI-GAS / VOC

CROSS SENSITIVITY DATA (continued)

GAS	CALCULATED TEST CONCENTRATION	TEST CONCENTRATION	READING IN PPM
Nitric Oxide NO	-	5ppm	Positive reading expected
Nitrogen Dioxide NO ₂	10ppm	1ppm	-1.2ppm
Ozone O ₃	0.755ppm	1ppm	-0.5ppm
Phosphine PH ₃	5ppm	1ppm	3.75ppm
Silane SiH ₄	-	1ppm	Positive reading expected
Sulphur Dioxide SO ₂	10ppm	1ppm	0.6ppm
Tetrahydrothiophene THT	-	1ppm	Positive reading expected
Trimethylamine C ₃ H ₉ N	-	1ppm	Positive reading expected

Sensor performance is temperature dependent. All performance specifications are based on test conditions with new sensors with the following environment conditions: +25°C, 50% relative humidity, 1 atm (1013 mBar or ambient pressure), flow rate > 150qcm/min. Cross-sensitivity gases are not target gases. Relationship can change overtime.

Whilst the SS sensor is designed to be highly specific to the gas it is intended to measure, it will still respond to some degree to various gases. The table is not exclusive and other gases not included in the table may still cause a sensor to react.

The cross-sensitivity values quoted are based on tests conducted on a small number of sensors. They are intended to indicate sensor response to gases other than the target gas. Sensors may behave differently with changes in ambient conditions and any batch may show significant variation from the values quoted.

The figures in this table are typical values and should not be used as a basis for cross calibration. Cross sensitivities may not be linear and should not be scaled. For some cross interference, break through will occur if gas is applied for a longer time period.

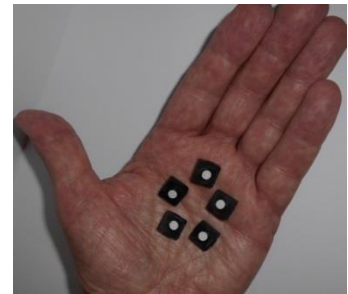

Notes: PCB sockets are recommended for the sensor pin connection. Soldering or using glue with the sensor should be avoided and will invalidate warranty. Socket connector information available on request. Sensors are designed to operate in a wide range of harsh environments and conditions. However, it is important to avoid exposure to high concentrations of solvent during storage, fitting into instrumentation and operation. When using sensors on PCBs, degreasing agents should be used prior to the sensor being fitted.

By the nature of the technology used, any sensor can potentially fail to meet specification without warning. Euro-Gas makes every effort to ensure reliability of all sensors but where life safety is a performance requirement of the product and, where practical, Euro-Gas recommends that all gas sensors and instruments using sensors are checked for response to gas before use. The data contained in this document is believed to be accurate and reliable. The data given is for guidance only. Euro-Gas Management Services Ltd accepts no liability for any consequential losses, injury or damage resulting from the use of this datasheet or the information contained in it. Customers should test the sensors under their own conditions to ensure that the sensors are suitable for their own requirements and in accordance with the plans and circumstances of the specific project and any standards/regulations pertaining to the country in which the sensors will be utilised. Performance characteristics on this data sheet outline the performance of newly supplied sensors. Output signal can drift below the lower limit over time. This datasheet is not intended to form the basis of a contract and in the interest of product improvement, Euro-Gas reserves the right to alter design features and specifications without notice. 2504

