

Nitrogen Dioxide Gas Module 0-100ppm

NO₂-100 SS Micro TX

Technical Specification

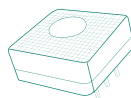

Solid Polymer Electrochemical Gas Technology

Small Size | Long Life | Low Cost | High Accuracy | Fast Response | Low Power Consumption

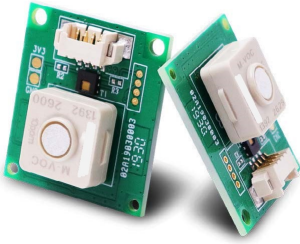

- ☞ High-precision environmental monitoring application;
- ☞ Strong anti-interference ability;
- ☞ Long life, stable detection and high reliability;
- ☞ New microcircuit design, strong anti-electromagnetic interference ability;
- ☞ Fast response, fast return to zero, plug and play;
- ☞ Independent temperature and humidity digital sensors, combined with intelligent algorithms, have stronger environmental adaptability, more accurate detection and long-term stability;
- ☞ Small size and low power consumption.

Product Overview

The SS Micro TX Nitrogen Dioxide module offers high-precision detection technology in both sensor and circuitry. The integrated sensor is a small solid polymer sensor which can detect very low concentrations of gases accurately and reliably. The module uses UART digital output for ease of use, eliminating the need for customers to understand detailed technical information of calibration.

Application

- ☞ Monitoring of Nitrogen Dioxide pollution in indoor parking lots
- ☞ Nitrogen Dioxide gas leakage monitoring



Principle

Solid polymer electrochemical technology is a revolutionary innovation in the field of electrochemical detection. This technology is based on the principle of electrochemical catalytic reaction, detecting the output signals of the electrochemical reactions of different gases, and accurately measuring the gas concentration through the signal.

The sensor consists of three electrodes in contact with the electrolyte. A typical electrode consists of a large surface area of precious metal and other materials. The electrode, electrolyte and the surrounding air are in contact, and the gas diffuses through the back of the porous membrane into the working electrode of the sensor. At this electrode, the gas is oxidized or reduced, and this electrochemical reaction causes a current to flow through the external circuit.

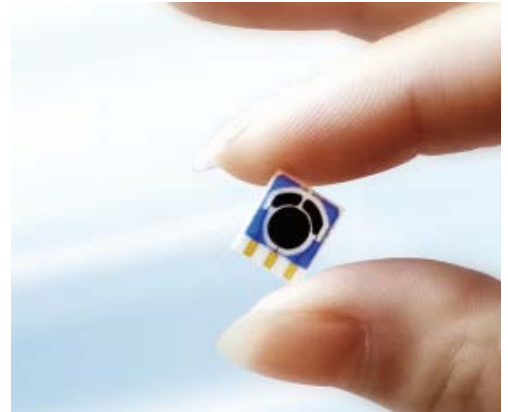

Features

- 👉 High accuracy and long life
- 👉 Fast response speed, fast return to zero, plug and play
- 👉 Good anti-toxicity
- 👉 Easy to use, UART digital signal output
- 👉 Durable and reliable
- 👉 Excellent accuracy, repeatability, linearity and consistency
- 👉 Zero drift
- 👉 Strong anti-electromagnetic interference ability
- 👉 With fixed mounting holes for easy installation
- 👉 Sleep design for low power IOT applications
- 👉 Independent temperature and humidity digital sensor output
- 👉 RoHS environmental design

Linearity

Temperature environment: 21°C ; Humidity environment: 55%; Air chamber space: 0.03m³; Ventilation flow of air distribution system: 4000sccm

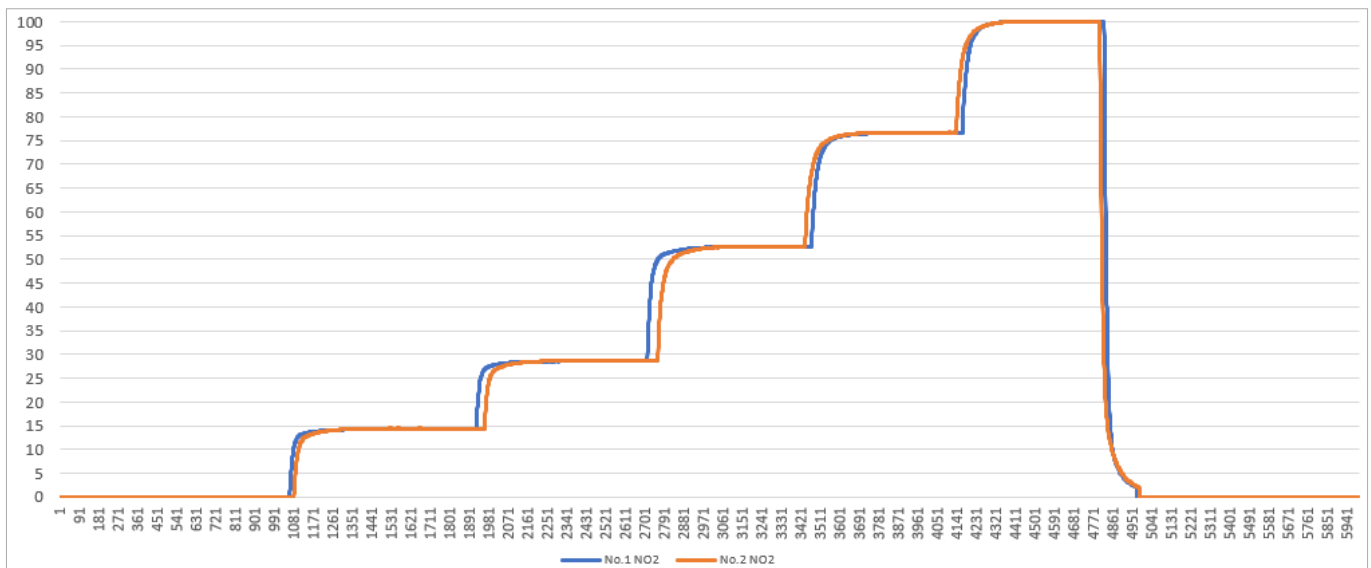

Test result: 100ppm full scale linearity error <± 5%;

Cross Sensitivity

Gas	Molecules formula	Concentration (ppm)	Response (ppm)
Nitrogen dioxide	NO ₂	10	10
Formaldehyde	HCHO	1	0
Hydrogen	H ₂	1000	0
Benzene	C ₆ H ₆	986.5	0
Ammonia	NH ₃	50	0
Ozone	O ₃	50	0
Methane	CH ₄	5000	0
Acetylene	C ₂ H ₂	80.3	0
Isobutene	C ₄ H ₈	300	0

Note: dimethylamine, hydrogen cyanide, toluene, xylene are below 50ppm and there is no interference, other concentrations need to be tested separately.

Zero Drift Testing (More than 12 hours)

Temperature environment: 21 °C ; Humidity environment: 50%; Environmental space: 0.03m³ air chamber, Ventilation flow of air distribution system: 4000sccm



Test result: 12 hours clean air test, zero drift <0.02ppm (0-0.02ppm is the normal zero fluctuation range);

Sensitivity Drift Testing

Temperature environment: 21°C ; Humidity environment: 55%; Air chamber space: 0.03m³; Ventilation flow of air distribution system: 4000sccm

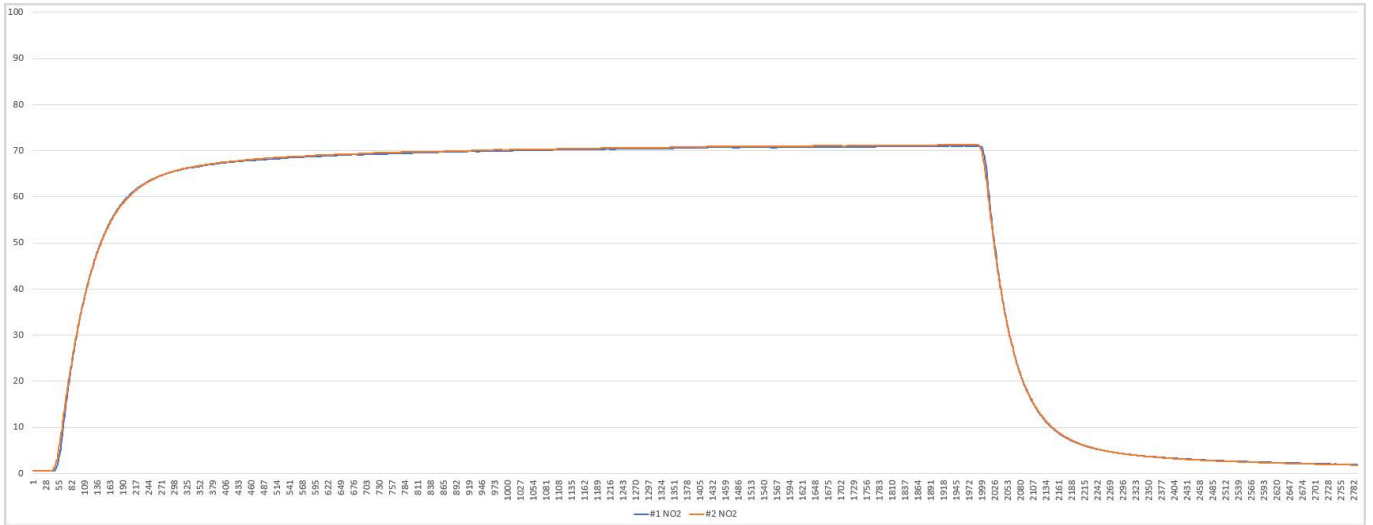

Test results: 2 hours ventilation, range drift <0.02ppm;

Repeatability

Temperature environment: 21°C ; Humidity environment: 50%; Air chamber space: 0.03m³; Ventilation flow of air distribution system: 4000sccm

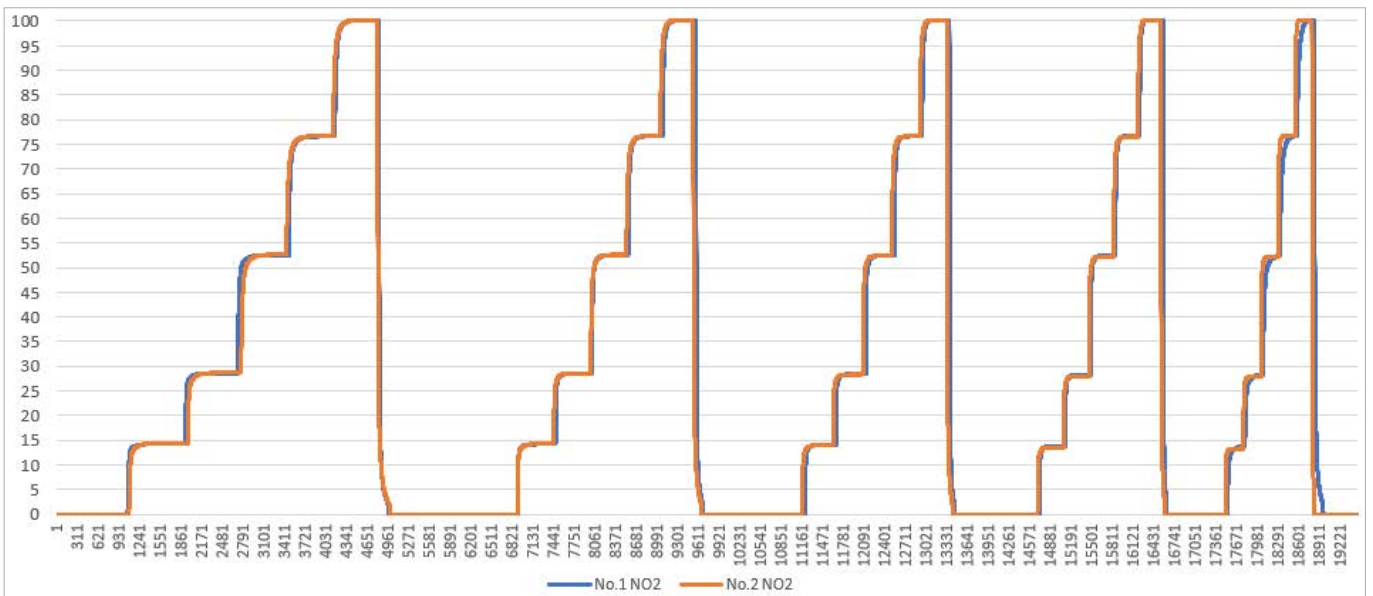

The test results show that (100ppm ± 1% of full scale is the normal range);

Structure Diagram

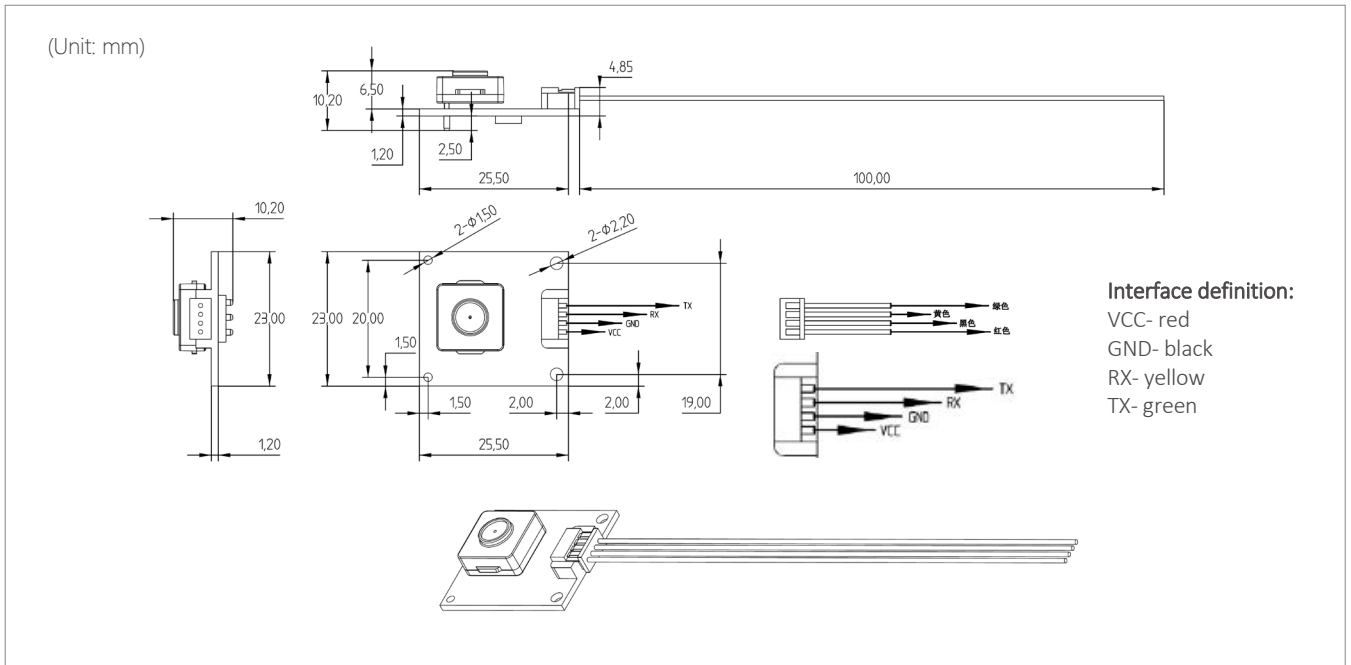

Order Information

Product	Part Number	Range	Resolution
NO2-100 SS Micro TX Nitrogen Dioxide Gas Module	2112B012750100	0-100ppm	0.1ppm
4 Pin Cable	2112B012762		

Specification

Principle	Solid Polymer Electrochemical Sensing Technology
Order number	2112B012750100
Detection of gas	Nitrogen Dioxide gas
Detection Range	0 - 100ppm; Display resolution: 0.1ppm
Lowest Detection Limit	1ppm
Full-scale accuracy error	±5% F.S
Warm-up time	Stored in clean air for the first time power on <120 seconds
	Stored in non-clean air for the first power-on <240 seconds (except in the presence of high concentrations of polluted gas)
Response time	<3 seconds (T50: <40 seconds; T90: <80 seconds; T100: <180 seconds)
Return zero time	<120 seconds (in 99.999% high purity nitrogen)
Calibration substance	100ppm measurement range: optional 5-90ppm nitrogen dioxide gas for calibration;
	Note: The smaller the range is, the higher the detection accuracy is. It is not recommended that users use it beyond the range.
Sensor life expectancy	More than three years in relatively clean air, temperature 0-25°C, humidity 30-70% (Sensor life will be reduced if often exposed to corrosive gas, high temperature environment and <20% low humidity environment)
Relative temperature error	± 0.2°C
Relative humidity error	± 2%
Output	3.3V UART digital signal (see below for communication protocol)
	Interface definition: VCC- red, GND- black, RX- yellow, TX- green
	Baud rate: 9600 Data bits: 8 bits Stop bits: 1 bit;
Get data command	Communication has active upload and Q & A mode. The default mode is Q & A mode after power-on. You can use instructions to switch between the two modes.
	Or Q & A mode is restored by power off or switch power mode
	See next page for details
Working Voltage	3.3 - 5.5V DC
Working Current	< 5mA
Power Consumption	25mW @ 5V DC
Repeatability	Full range 100ppm ± 1% is the normal range
Working temperature	0-40°C, storage temperature -20 to +55°C (with temperature compensation). Suitable for both indoor and outdoor use. If applied in outdoor or industrial environment, it is recommended that customers choose suitable housing protection to protect sensors from outdoor and harsh elements.
Optimal working temperature	20 - 35°C
Working humidity	15% - 95% RH. (Non-condensing)
Optimum working humidity	40 - 70% RH.
Working pressure	Atm ± 10%
Board size	23 x 25.5 x 10.2mm (with sensor)
Board size	23 x 25.5 x 4.85mm (without sensor)
Weight	3.1g
Signal cable	The standard length is shown in the figure, and can be customized if there are special requirements.

User Guide

Thank you for choosing our Micro TX module. Before using it, please read this document in detail in order to use our products correctly and effectively.

Storage

The solid-state polymer sensor can be stored for more than 1 year at a humidity of 20-95% and a temperature of -5°C to +25°C. Ensure that the storage environment is free from high concentrations of contaminated gases. Sensors that have been stored for more than 6 months should first have a power-on polarization time of more than 12 hours to fully activate the electrolyte and restore best detection state.

1. The best storage environment is: temperature -5°C to +25°C, relative humidity 25% to 95% (non-condensing);
2. The storage environment should be clean air, no pollution gas, no high concentration organic gas, no dust, no smoke;
3. Avoid storage with alcohol (ethanol), perfume, sodium silicate, and polyurethane liquids and solids.

Packaging and transportation

1. Avoid prolonged direct sunlight during transportation, prevent rainwater penetration;
2. Transport packaging should provide protection with shock-proof bubble film or odourless environmentally friendly sponge;
3. During long-term long-distance transportation, the temperature in the sensor package should be kept below 40°C as much as possible, and the maximum temperature should not exceed 55°C (do not store or use at this temperature for a long time);
4. During transportation of the finished product, seal the air inlet of the sensor as much as possible to prevent contaminated gas from entering the sensor, which will cause high values or long stabilization time when the product is used for the first time.

Steps for usage

1. Wiring

- Perform the corresponding wiring according to the identification of the output signal port of the structure diagram. Please refer to the 4 Pin signal line label in the "Structure Diagram" above (Page 6). For the power supply, see the voltage and current ranges marked in the indicators. **Note: incorrect wiring will cause the module to malfunction or damage the module.**

2. Warm-up time

- The NO₂ module needs a short stabilization time after power-on. The module is designed with plug-and-play function, and usually the stabilization time is within 2 minutes. However, if the concentration of contaminated gas is high during storage, transportation or on-site environment, the stabilization time will increase. If the on-site ambient air is highly fluid, there will be fluctuations in the data. Please pay close attention to the on-site environment status. When the environmental condition is stable and there is no strong convection and air exchange (such as open windows, open doors, fans, air conditioners, fresh air systems, etc.), as soon as the output signal is constant detection can begin.
- (Note: Since it is high-precision module, the first power-on stabilization time varies under different storage and measurement environments.)
- When the module is stable, NO₂ gas is usually present in normal air. Please refer to the NO₂ data released by the nearest local environmental monitoring station for reference.

3. Diffusion use

- The module functions by diffusion detection, that is, the airflow naturally diffuses into the sensor. When the environment has a flow rate, it is necessary to ensure that the flow rate is within 500ml and that the flow rate is stable. A change of flow will cause the signal to fluctuate. When the flow is large, it will bring a change of pressure, which will cause the sensor signal value to change. The flow velocity will generate pressure, and the change in pressure will cause the output signal to change. The signal will increase when the pressure increases and the sensor signal will change suddenly when the pressure changes suddenly. Avoid negative pressure environments which will cause irreparable physical damage to the sensor.

4. Temperature and humidity effects

- The module has been corrected for temperature compensation through an intelligent algorithm, which is suitable for the detection environment of 0 to +40°C. The sensor can work in the environment of -40 to 55 °C. There will be detection values in the temperature range outside the temperature compensation. The deviation is large. If you have special requirements, please contact us to discuss customization.

User Guide

- The sensor is not affected by normal humidity changes, but rapid humidity changes will cause instantaneous peak changes. This is mainly due to condensation on the sensor surface caused by humidity changes, which will prevent outside air from entering the sensor, but the sensor will stabilize within a short time. Frequent and rapid changes in temperature or humidity will affect the chemical materials and cause the sensor life to be unexpectedly reduced. Due to the principle and characteristics of electrochemical sensors, changes in the environment have different levels of influence on the chemical electrolyte inside the sensor. The NO₂ sensor module analyzes the changes of the sensor current data in detail through different environmental temperature and humidity impact tests, and combines the temperature and humidity sensor data to perform algorithmic compensation. During use of the sensor, pay attention to sudden changes in temperature and humidity which will cause the sensor data to fluctuate abnormally. The NO₂ sensor has good adaptability to the environment. Generally, it can fully adapt to the new environment and stabilize in 5-10 minutes.
- The sensor module must not be used and stored for a long time in a high-temperature and low-humidity environment with humidity below 10% and a temperature above 55°C. Doing so may result in reduced sensor life, or failure, or invalid test data.

Precautions

1. The main function of the gas sensor is to detect the gas composition and content. Please do not let any part of the sensor contact liquid;
2. Different gas sensors have different measurement concentration ranges. Do not measure high-concentration gases for a long period;
3. The white or yellow sheet on the sensor is a waterproof and breathable film - please be careful not to scratch or pull it off;
4. Do not block or contaminate the surface of the sensor. Sometimes blockage of the hole is the cause of reduced sensitivity and slow response time;
5. Please do not exchange the sensors on different gas modules. Doing so will cause measurement errors, because all the parameters of each sensor and each circuit board are matched and calibrated, and there will be deviations after the exchange;
6. Once the sensor is unplugged and re-inserted into the circuit board, please check that the three electrodes of the sensor correspond to the socket on the circuit board correctly to avoid irreversible damage to the sensor after reverse insertion;
7. Avoid excessive impact or vibration. If the case is broken and the internal structure is exposed, the output will no longer be reliable;
8. Pins must not be broken or bent. Doing so may damage the internal structure of the sensor;
9. The sensor will be slow to return to the initial state after long-term use in a high-concentration gas environment. The recovery speed is proportional to the overrange multiple;
10. The sensor should not be used in high concentrations and strong viscous gas for a long time period;
11. Please do not disassemble the sensor as it will damage the sensor;
12. Measurement range and accuracy. Select a gas sensor that matches the range and accuracy according to the actual application requirements and the gas concentration range. Otherwise, the gas may not be detected, accurate data may not be judged, and the sensor may be damaged;
13. When conducting on-site detection of NO₂ gas, avoid the interference of other high-concentration gases on the site with NO₂, which will cause the error rate of the test results to increase.
14. Due to the principle and characteristics of the electrochemical sensor, in order to ensure the long life and the best working state of the sensor, the sensor should be kept in a continuous power state as much as possible;
15. When the NO₂ module encounters high-concentration gases during use, such as NO₂ gas, ethanol gas, and volatile organic gas, after impact the recovery time will be slower. Placement in a clean air environment can shorten the recovery time.

Sensor quality inspection

1. Each sensor produced is factory inspected, with a comprehensive performance test of the main indicators of the sensor. In the sensor manufacturing process, we perform four index tests in different process links to screen out nonconforming products. After production and before delivery, each sensor is tested. The sensors are installed in a gas distribution test system, and tested with full-scale certified standard gas for a continuous 3-5 minutes. After the test is completed, the system will automatically generate a standard sensor test report (including: serial number, sensitivity, response time T50 T90, return zero time, zero current, maximum current value) strictly in accordance with the system preset parameters of standard qualified products. Sensors are rejected where standards are not met and then treated as nonconforming products.

User Guide

2. All modules are calibrated with certified standard gas to ensure the consistency and accuracy of the sensor.

Disclaimer

Performance data stated above is based on data obtained with new sensors under test conditions using our gas distribution system and test software.

Cross sensitivity gases are not target gases. Performance characteristics on this data sheet outline the performance of newly supplied sensors. Output signal can drift below the lower limit over time. Relationships and performance can change with ageing of the sensor.

Sensors are designed to operate in a wide range of harsh environments and conditions. However, it is important to avoid exposure to high concentrations of solvent during storage, fitting into instrumentation and operation. By the nature of the technology used, any sensor can potentially fail to meet specification without warning. Euro-Gas makes every effort to ensure reliability of all sensors but where life safety is a performance requirement of the product and, where practical, Euro-Gas recommends that all gas sensors and instruments using sensors are checked for response to gas before use.

At the end of the product's service life, please do not discard any electronics in household waste. Please dispose it in accordance with local government regulations on electronic waste recycling.

The data contained in this document is believed to be accurate and reliable. The data given is for guidance only. Euro-Gas Management Services Ltd accepts no liability for any consequential losses, injury or damage resulting from the use of this datasheet or the information contained in it. Customers should test the sensors under their own conditions to ensure that the sensors are suitable for their own requirements and in accordance with the plans and circumstances of the specific project and any standards/regulations pertaining to the country in which the sensors will be utilised.



Sensor Production Test

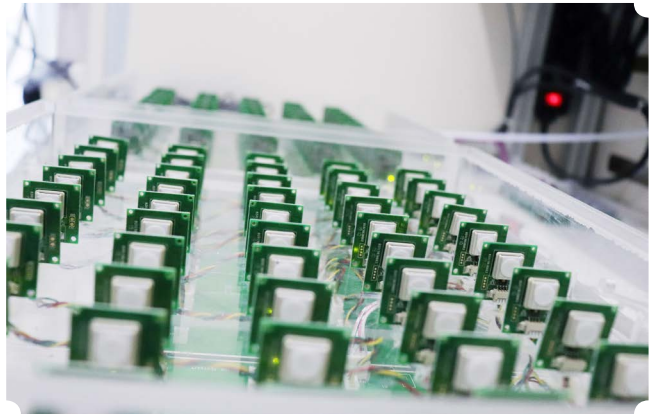

Test module, test calibration



This datasheet is not intended to form the basis of a contract and in the interest of continued product improvement, Euro-Gas reserves the right to change design features and specifications without prior notification. We do not accept any legal responsibility for customer applications of our sensors. Euro-Gas accepts no liability for any consequential losses, injury or damage resulting from the use of this document, the information contained within or from any omissions or errors here in. This document does not constitute an offer for sale and the data contained is for guidance only and may not be taken as warranty. Any use of the given data must be assessed and determined by the user there of to be in accordance with federal, state and local laws and regulations. All specifications outlined are subject to change without notice.



Communication Protocol

General Settings

The sensor module uses serial communication. The communication configuration parameters are as follows:

Baud rate	9600
Data bits	8 bits
Stop bits	1 bit
Parity bit	None

Note: The communication has active upload and question-and-answer mode. The default mode is Q & A mode after power-on. You can use commands to switch between the two modes. After power-off or switch power consumption mode, the Q&A mode is restored.

Transmission mode switching instruction

Command 1 Switches to active upload. The command line format is as follows:

0	1	2	3	4	5	6	7	8
Start bit	Retain	Switch command	Active upload	Retain	Retain	Retain	Retain	Checksum
0xFF	0x01	0x78	0x40	0x00	0x00	0x00	0x00	0x47

Note: This format is fixed

Command 2 Switch to passive upload. The command line format is as follows:

0	1	2	3	4	5	6	7	8
Start bit	Retain	Switch command	Answer	Retain	Retain	Retain	Retain	Checksum
0xFF	0x01	0x78	0x41	0x00	0x00	0x00	0x00	0x46

Note: This format is fixed

Commands in query mode

Command 3 Get the sensor type, maximum range, unit, and decimal places: 0xD1

Return value:

0	1	2	3	4	5	6	7	8
Sensor type	Maximum range high	Maximum range low	Unit	Retain	Retain	Retain	Number of decimal places(bit[4]~bit[7]) Data sign (bit[0]~bit[3])	Parity bit
0x21	0x00	0xC8	0x02	0x00	0x00	0x00	0x01	0x35

Note:

Max range = (Max range high << 8) | Max range low

Unit: 0x02 (ppm and mg / m³) 0x04 (ppb and ug / m³)

Signs: 0 (positive) 1 (negative)

Decimal places: how many decimal places to read the concentration value, the maximum number of decimal places is 3

Communication Protocol

Command 4 Get the sensor type, maximum range, unit, and decimal places: 0xD7

0	1	2	3	4	5	6	7	8
Command header 1	Command header 2	Sensor type	Maximum range high	Maximum range low	Unit	Number of decimal (bit[4]~bit[7]) Data sign (bit[0]~bit[3])	Retain	Parity bit
0xFF	0xD7	0x21	0x00	0xC8	0x02	0x01	0x00	0x3D

Description:

Checksum: Add 1 ~ 7 to generate an 8-bit data, invert each bit, add 1 at the end

Decimal places bit [4] ~ bit [7]:

$(\text{bit}[7] \ll 3) | (\text{bit}[6] \ll 2) | (\text{bit}[5] \ll 1) | \text{bit}[4]$ = number of decimal places

Data sign (bit[0]~bit[3]):

$(\text{bit}[3] \ll 3) | (\text{bit}[2] \ll 2) | (\text{bit}[1] \ll 1) | \text{bit}[0] = 0$ Negative inhibition

$(\text{bit}[3] \ll 3) | (\text{bit}[2] \ll 2) | (\text{bit}[1] \ll 1) | \text{bit}[0] = 1$ Positive inhibition

Unit :

0x02: unit is mg/m³ and ppm

0x04: unit is um/m³ and ppb

0x08: unit is 10g/m³ and %

Command 5 The format for actively reading the gas concentration value is as follows:

0	1	2	3	4	5	6	7	8
Start bit	Retain	Command	Retain	Retain	Retain	Retain	Retain	Checksum
0xFF	0x01	0x86	0x00	0x00	0x00	0x00	0x00	0x79

Return value:

0	1	2	3	4	5	6	7	8
Start bit	Command	High gas concentration (ug/m ³)	Low gas concentration (ug/m ³)	Full range high	Full range low	High gas concentration (ppb)	Low gas concentration (ppb)	Checksum
0xFF	0x86	0x00	0x2A	0x00	0x00	0x00	0x20	0x30

Description:

Checksum: Add 1 ~ 7 digits of data to generate an 8-bit data, invert each bit, add 1 at the end.

Gas concentration value = gas concentration high bit * 256 + gas concentration bit;

(The high and low concentrations need to be converted from hexadecimal to decimal and then brought into this formula to calculate)

Communication Protocol

Command 6 Combined reading command of gas concentration value and temperature and humidity

0	1	2	3	4	5	6	7	8
Start bit	Retain	Command	Retain	Retain	Retain	Retain	Retain	Checksum
0xFF	0x01	0x87	0x00	0x00	0x00	0x00	0x00	0x78

Return value:

0	1	2	3	4	5	6	7	8	9	10	11	12
Start bit	Command	High gas concentration (ug/m ³)	Low gas concentration (ug/m ³)	Full range high	Full range low	High gas concentration (ppb)	Low gas concentration (ppb)	Temperature high	Temperature low	Humidity high	Humidity low	Parity bit
0xFF	0x87	0x00	0x2A	0x03	0xE8	0x00	0x20	0x09	0xC4	0x13	0x88	0xDC

Description:

Checksum: 1 ~ 11 bits of data are added to generate an 8-bit data, each bit is inverted, and 1 is added at the end.

Gas concentration value = gas concentration high bit * 256 + gas concentration bit;

(The high and low concentrations need to be converted from hexadecimal to decimal and then brought into this formula to calculate)

Temperature is signed data with two decimal places, the unit is (°C -Celsius). Pseudo code calculation formula:

$$T = (\text{float})((\text{int})((0x0A \ll 8) | 0x09)) / 100$$

Humidity is data without sign and two decimal places, the unit is (rh%). Pseudo code calculation formula:

$$Rh = (\text{float})((\text{uint})((0x0A \ll 8) | 0x09)) / 100$$

Command 7 Get the current temperature and humidity:

Return value:

0	1	2	3
Temperature high 8 bit	Temperature low 8 bit	Humidity high 8 bit	Humidity low 8 bit
0x0A	0x09	0x11	0xF4

Description:

Temperature is signed data with two decimal places, the unit is (°C -Celsius). Pseudo code calculation formula:

$$T = (\text{float})((\text{int})((0x0A \ll 8) | 0x09)) / 100$$

Humidity is data without sign and two decimal places, the unit is (rh%). Pseudo code calculation formula:

$$Rh = (\text{float})((\text{uint})((0x0A \ll 8) | 0x09)) / 100$$

Communication Protocol

Command 8 Get the current temperature and humidity with calibration

Return value:

0	1	2	3	4
Temperature high 8 bit	Temperature low 8 bit	Humidity high 8 bit	Humidity low 8 bit	Checksum
0x0A	0x09	0x11	0xF4	0xE8

Description:

Checksum: 0 ~ 3 bits of data are added to generate an 8-bit data. Each bit is inverted, plus 1 at the end.

Temperature is data with a sign and two decimal places. The unit is (°C -Celsius). Pseudo-code calculation formula:

$$T = (\text{float})((\text{int})((0x0A \ll 8) | 0x09)) / 100$$

Humidity is data without sign and two decimal places, the unit is (rh%). pseudo code calculation formula:

$$Rh = (\text{float})((\text{uint})((0x0A \ll 8) | 0x09)) / 100$$

Command 9 Get the current version number

Return value:

0	1	2	3	4	5
0x19	0x05	0x27	0x00	0x10	0x01

Data active upload mode

The upload data format is as follows:

0	1	2	3	4	5	6	7	8
Start bit	Command	High gas concentration (ug/m ³)	Low gas concentration (ug/m ³)	Full range high	Full range low	High gas concentration (ppb)	Low gas concentration (ppb)	Checksum
0xFF	0x86	0x00	0x2A	0x00	0x00	0x00	0x20	0x30

Note:

Checksum: 1 ~ 11 bits of data are added to generate an 8-bit data, each bit is inverted, and 1 is added at the end.

Gas concentration value = gas concentration high bit * 256 + gas concentration bit;

(The high and low concentrations need to be converted from hexadecimal to decimal and then brought into this formula to calculate)

Communication Protocol

Low power switching

Enter sleep mode

0	1	2	3	4	5
0xAF	0x53	0x6C	0x65	0x65	0x70

Return value:

0	1
0x4F	0x4B

Exit sleep mode

0	1	2	3	4
0xAE	0x45	0x78	0x69	0x74

Return value:

0	1
0x4F	0x4B

Note: After exiting sleep mode, it takes 5 seconds to recover, no data within 5 seconds

0x19,0x07,0x06,0x13,0x47,0x25 Low power instructions that can be used later

Enter sleep mode

0	1	2	3	4	5	6
0xA1	0x53	0x6C	0x65	0x65	0x70	0x32

Return value:

0	1	2	3	4	5	6	7	8
0xFF	0xA1	0x00	0x00	0x00	0x00	0x00	0x00	5F

Exit sleep mode

0	1	2	3	4	5
0xA2	0x45	0x78	0x69	0x74	0x32

Return value:

0	1	2	3	4	5	6	7	8
0xFF	0xA2	0x00	0x00	0x00	0x00	0x00	0x00	5E

Communication Protocol

Turn off the running lights

0	1	2	3	4	5	6	7	8
Start bit	Retain	Command	Retain	Retain	Retain	Retain	Retain	Checksum
0xFF	0x01	0x88	0x00	0x00	0x00	0x00	0x00	0x77

Return:

0	1
0x4F	0x4B

Turn on the running lights

0	1	2	3	4	5	6	7	8
Start bit	Retain	Command	Retain	Retain	Retain	Retain	Retain	Checksum
0xFF	0x01	0x89	0x00	0x00	0x00	0x00	0x00	0x76

Return:

0	1
0x4F	0x4B

Query the running light status

0	1	2	3	4	5	6	7	8
Start bit	Retain	Command	Retain	Retain	Retain	Retain	Retain	Checksum
0xFF	0x01	0x8A	0x00	0x00	0x00	0x00	0x00	0x75

Return:

0	1	2	3	4	5	6	7	8
Start bit	Command	State value	Retain	Retain	Retain	Retain	Retain	Checksum
0xFF	0x8A	0x01	0x00	0x00	0x00	0x00	0x00	0x75

Note: Status value 1 (light on), 0 (light off)



**EURO-GAS MANAGEMENT SERVICES LTD, CHURSTON HOUSE,
BASCOMBE ROAD, CHURSTON FERRERS, DEVON, TQ5 0JJ, UK**

☎: +44 (0)1803 844414

sales@euro-gasman.com

www.euro-gasman.com

EURO-GAS
MANAGEMENT SERVICES LTD